

TLP 3844-Z Parts Catalog

View 1

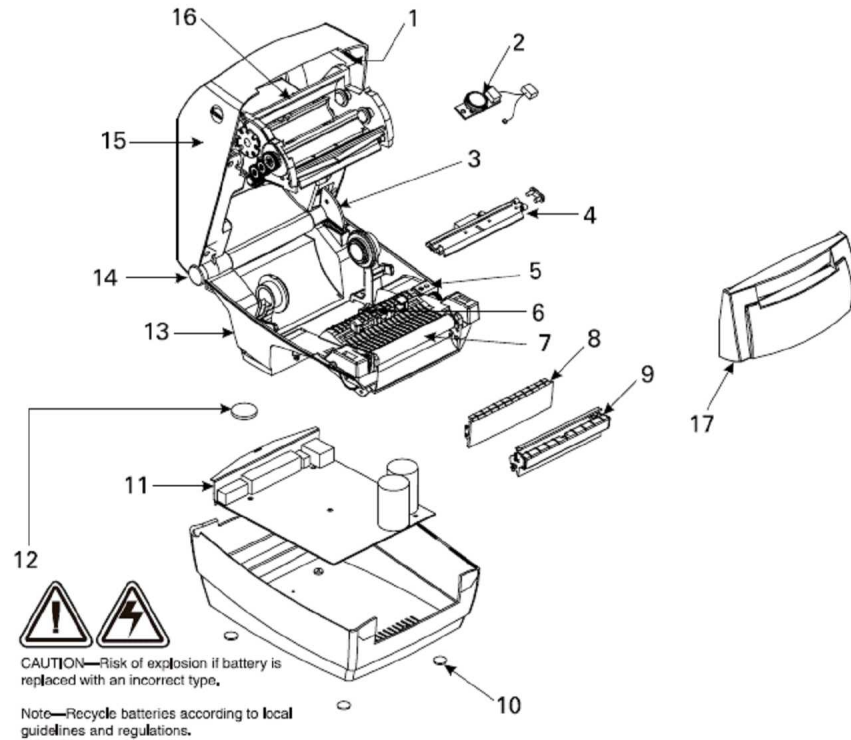

Item Number	Description	Part Number	Kit Quantity
1	Latch Assy.	105910-052	1
2	Feed Switch / Sensor Assy.	G105916-030	3
3	Upper Cover Support	G105910-066	3
4	Printhead Assy., (300 dpi)	G105910-155	1
4	Print Head Cable Assy.	105910-065	1
5	Head Up Sensor	G105916-015	1
6	Gap / Blackline Sensor PCBA	G105910-054	3
7	Platen Kit, std.	105910-055	3
8	Front Bezel, std.	105910-057	10
9	Front Bezel, Dispenser	G105916-003	1
9	Label Taken Sensor PCBA	G105916-001	3
10	Rubber Foot Kit	105910-007	24
11	Main Control PCBA, Std. Memory, Ser./Par./USB	G105916-009	1
11	Main Control PCBA, Std. Memory, Ser./Ethernet/USB	G105916-010	1
11	Main Control PCBA, Full Memory, Ser./Par./USB	G105916-011	1
11	Main Control PCBA, Full Memory, Ser./Ethernet/USB	G105916-012	1
11	Interface Protection Fuse, 1A	G105950-056	10
11	Kit, Ethernet IO PCBA with cables	G105910-121	1
11	Kit, PrintServerII Daughter Board	G105910-123	1
11	Kit, 4 Ethernet Back Panel	G105910-124	1
12	Battery, 3V Lithium	G105950-003	10
13	Bottom Frame Assy.	G105916-031	1
14	Cover Hinge	G105910-074	10
15	Upper Cover Assy.	G105910-060	1
16	Ribbon Out Sensor	G105916-028	3
17	Cutter Replacement Kit	G105910-028	1

**TLP 3844-Z Parts Catalog**

Item Number	Description	Part Number	Kit Quantity
	Motor, Assy.	G105910-161	2
	Power Supply, 100V-240V (C5) with US & Euro Cords (200dpi)	105950-060	1
	Power Supply, 100V-240V (C5) with UK & EUR Cords (200dpi)	105950-076	1
	Power Cord, U.S. 120V, IEC320C5	105950-061	5
	Power Cord, Euro 220V, IEC320C5	105950-062	5
	Power Cord, U.K. 240V, IEC320C5	105950-063	5
	Power Cord, Australia 240V, IEC320C5	105950-064	5
	Power Cord, China 220V, IEC320C5	105950-065	5
	Power Cord, Argentina 220V, IEC320C5	105950-066	5
	Power Cord, Japan 125V, IEC320C5	105950-077	5
	Ribbon Core, 4 thermal transfer	105903-053	50
	Ribbon Carriage w/o Printhead	G105916-029	1
	Shipping Pack	105950-050	1
	CD-ROM, ZPL Desktop Printers Software & Documentation	105950-053	1
	CD-ROM, Service Documentation	105950-051	1